

Easter Egg

El Huevo de Pascua

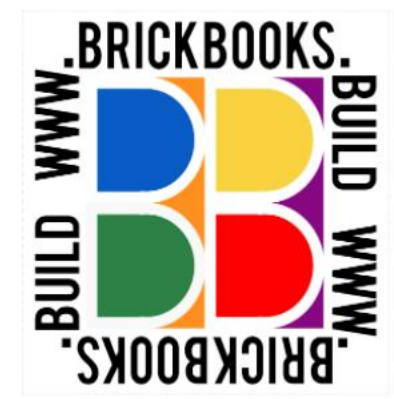

1

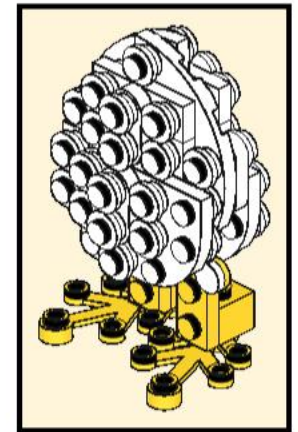
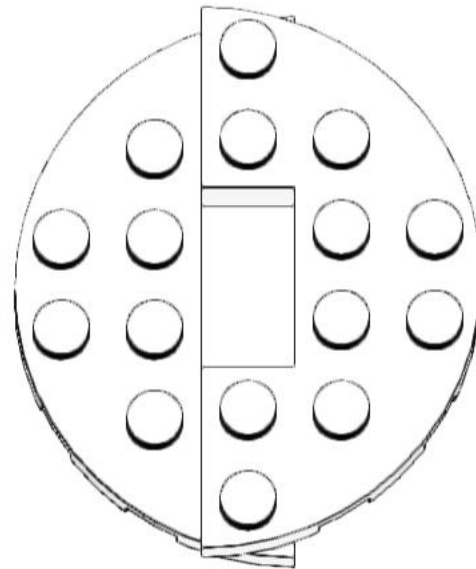
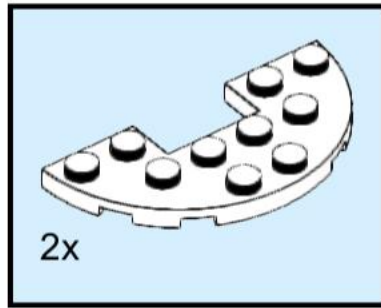

2

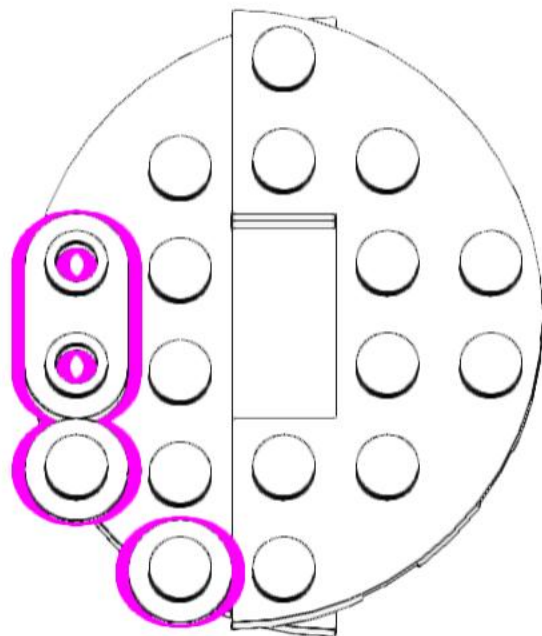
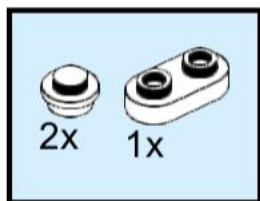

3

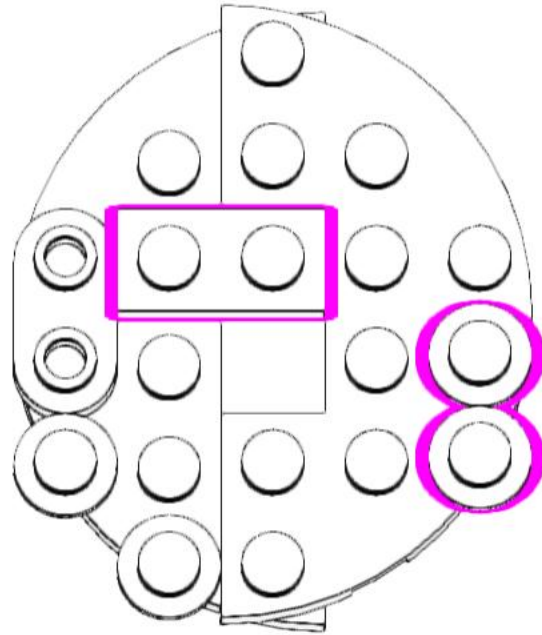
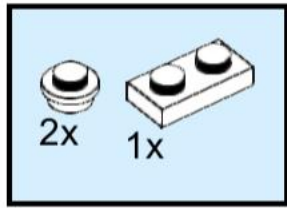

5

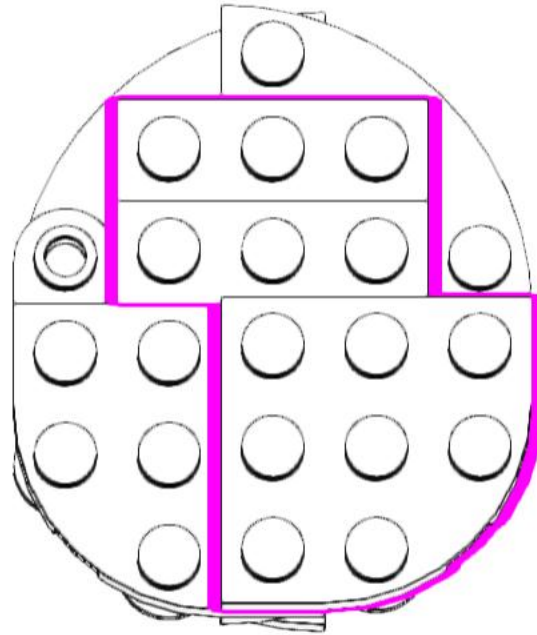
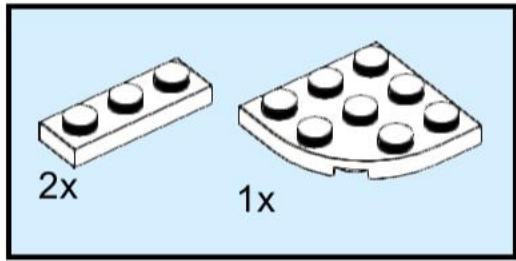

6

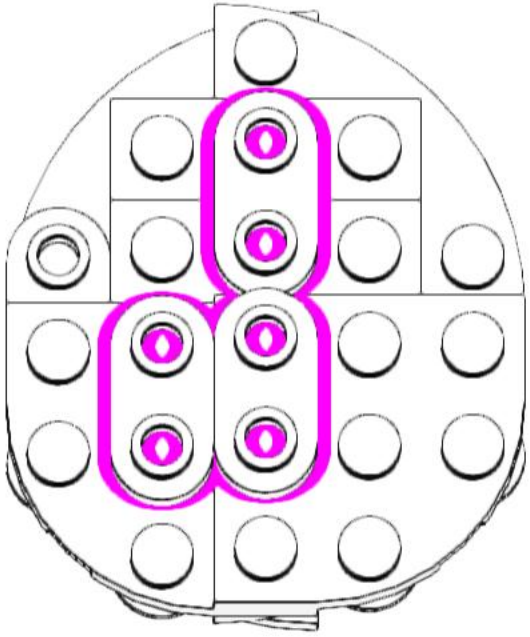
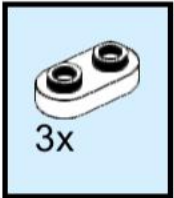

7

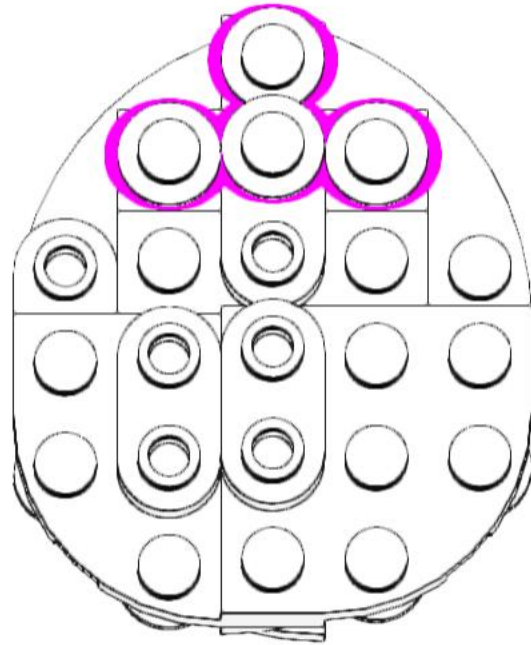
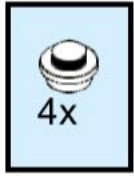

8

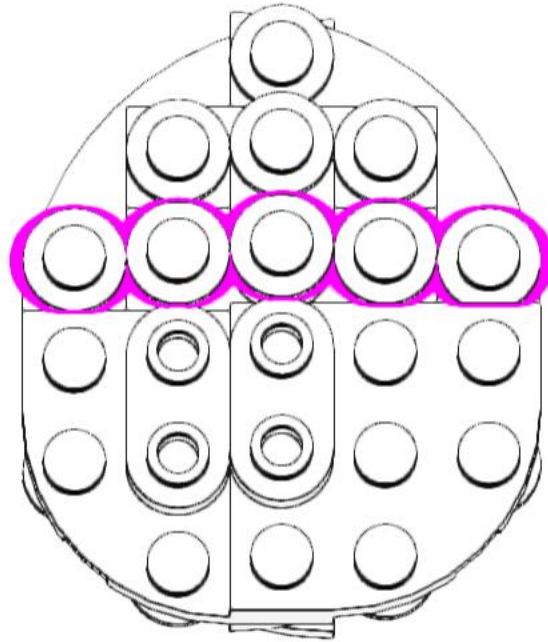
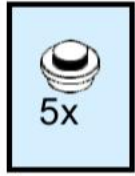

9

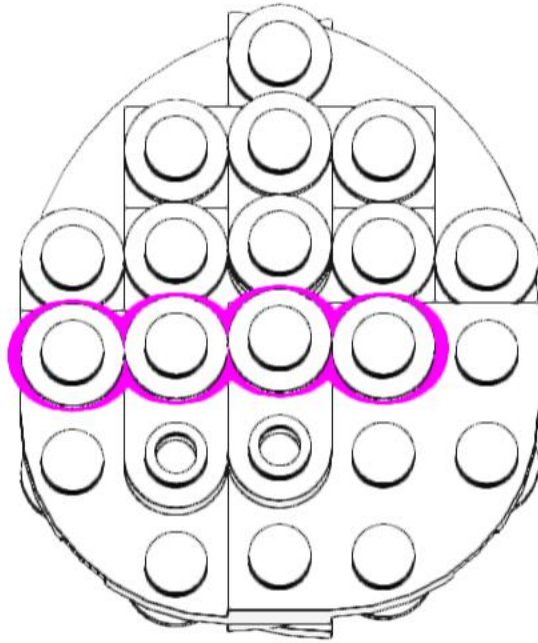
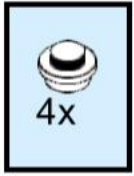

10

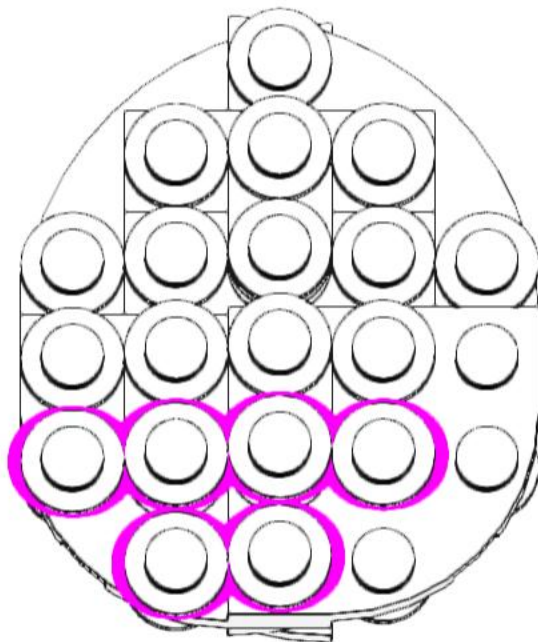
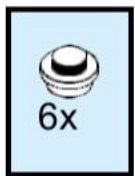

11

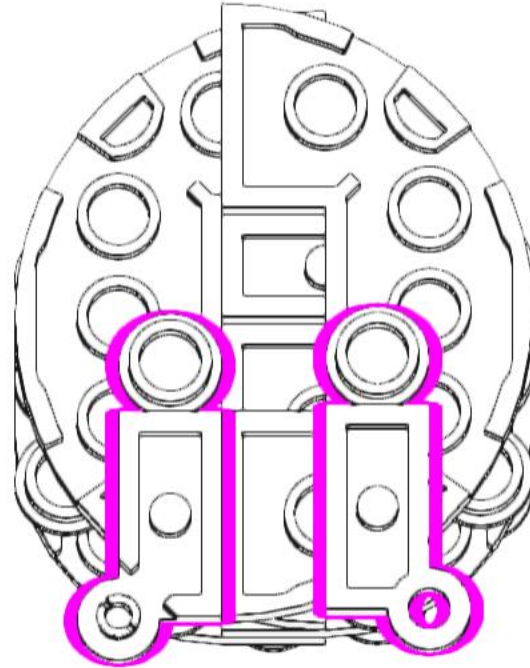
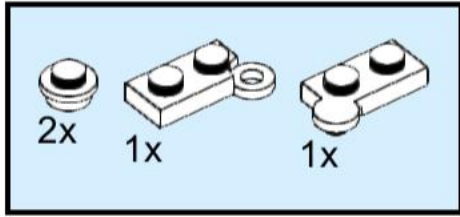

12

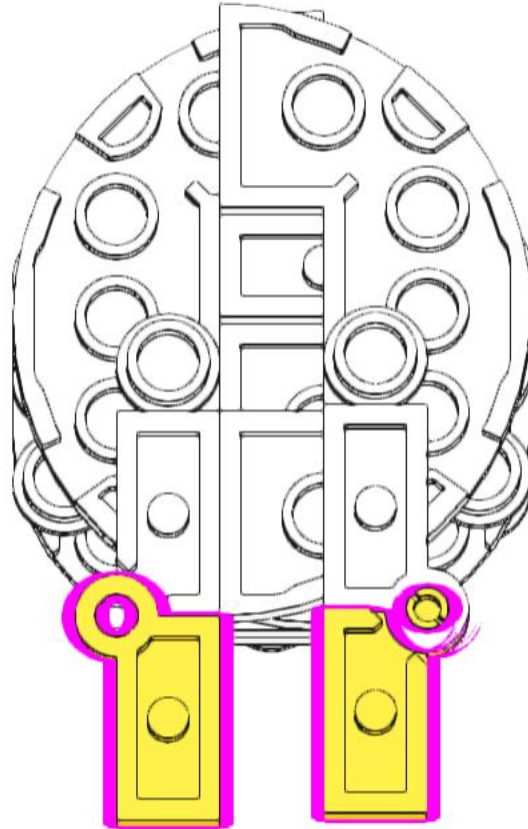
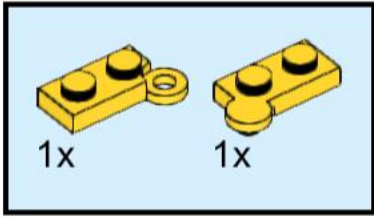

13

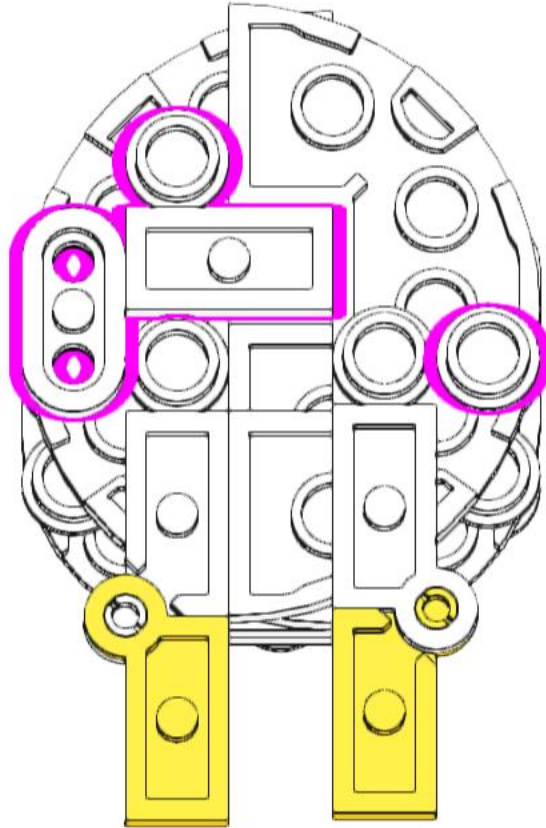
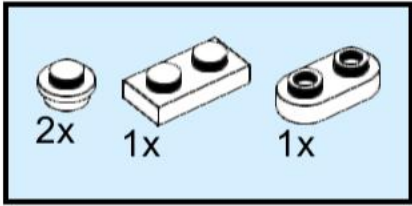

14

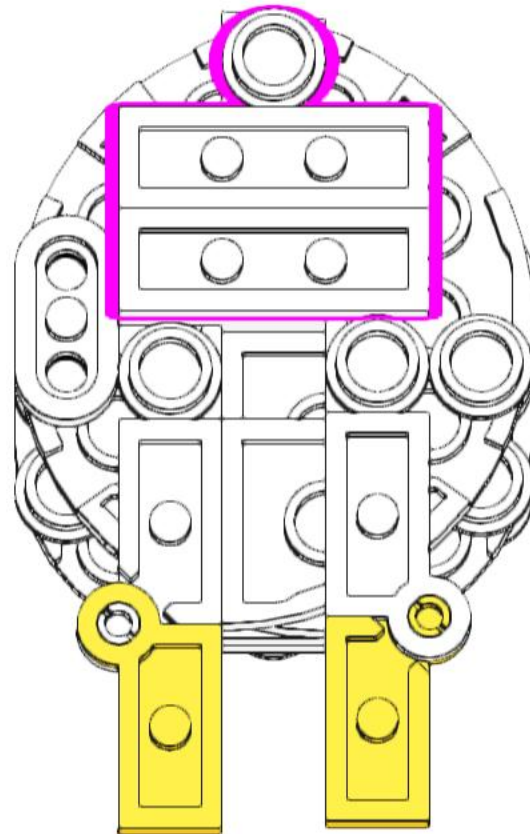
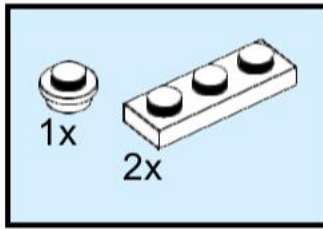

15

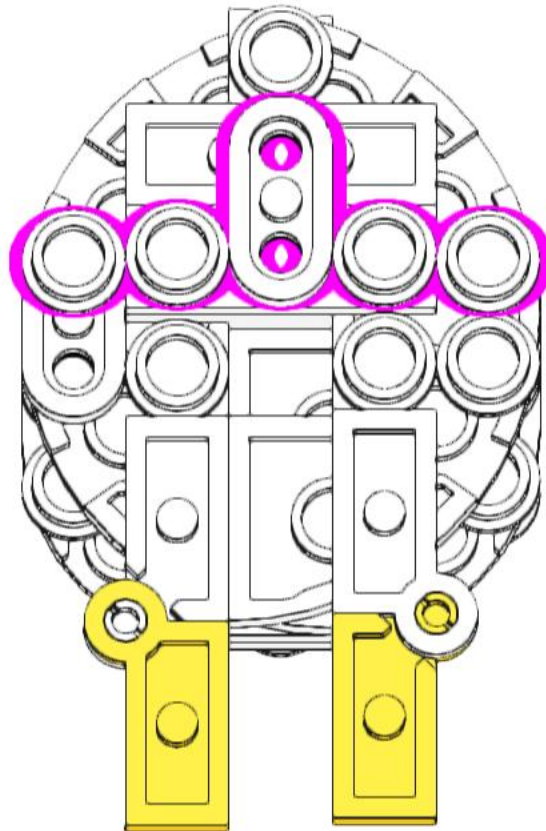
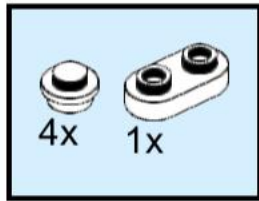

16

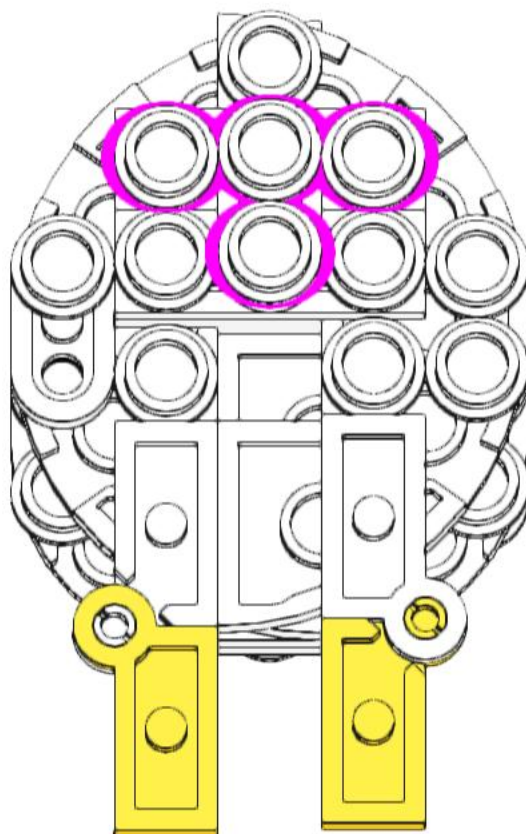

17

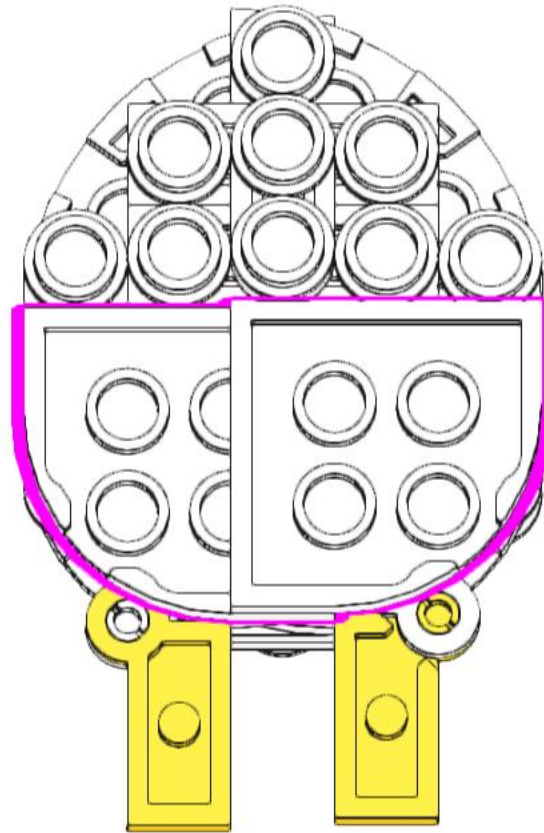
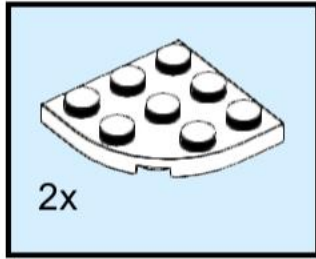

18

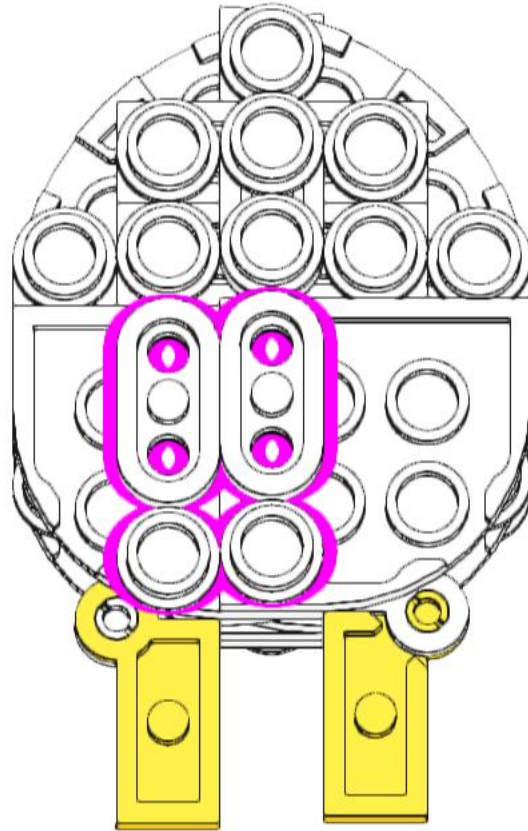
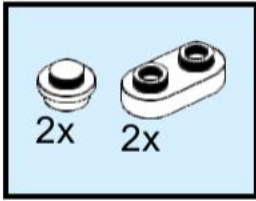

19

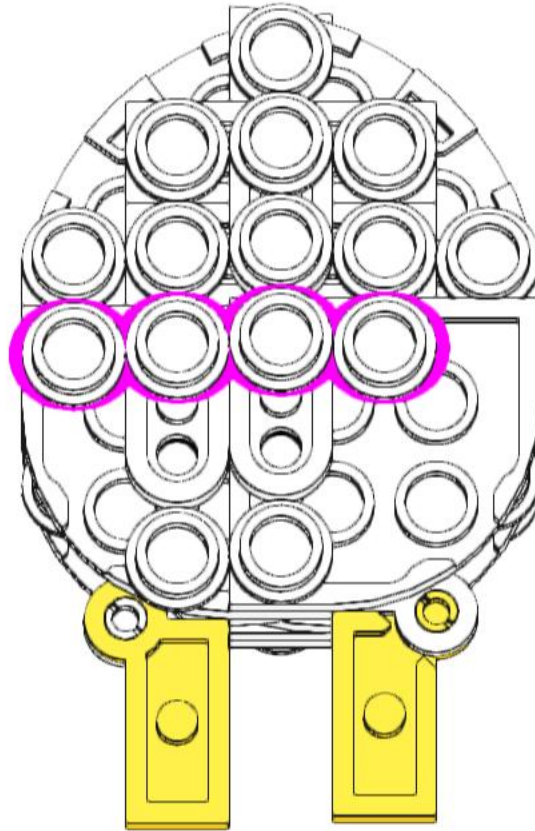
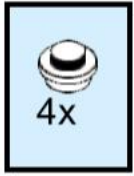

20

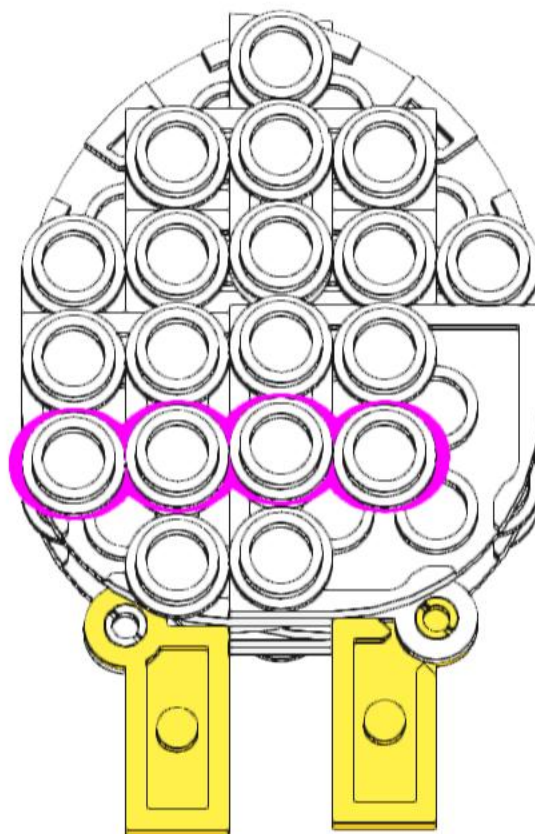
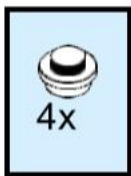

21

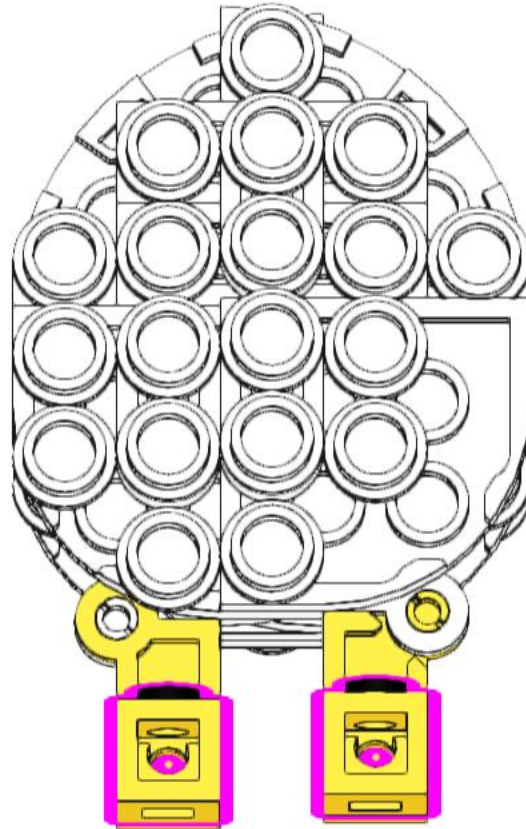
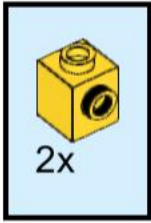

22

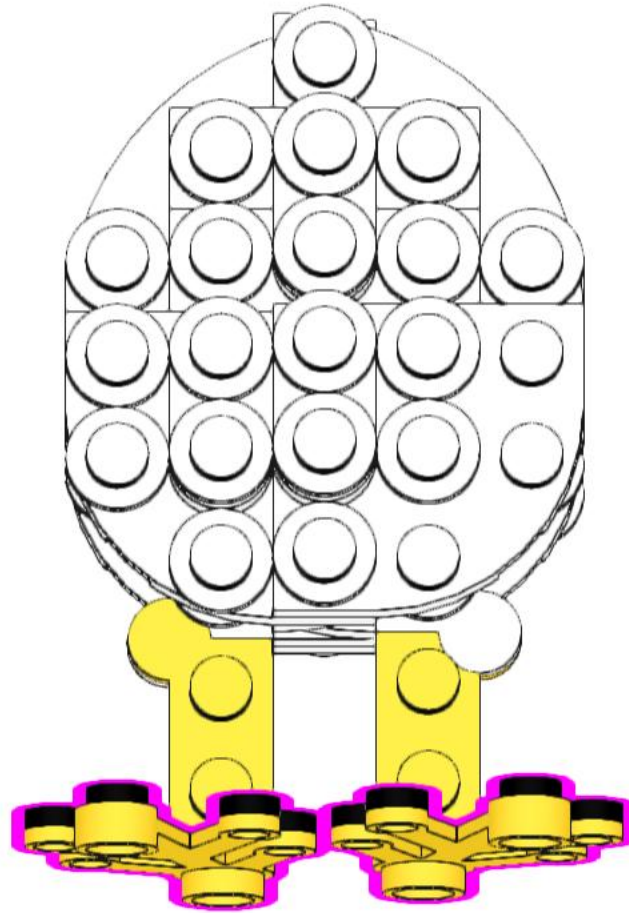
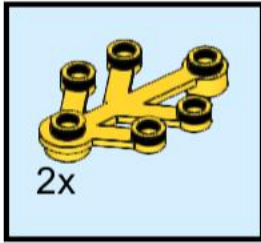

Now you can decorate (and re-decorate) your egg with the colorful 1x1 round studs. You can also add any other building bricks you might have.

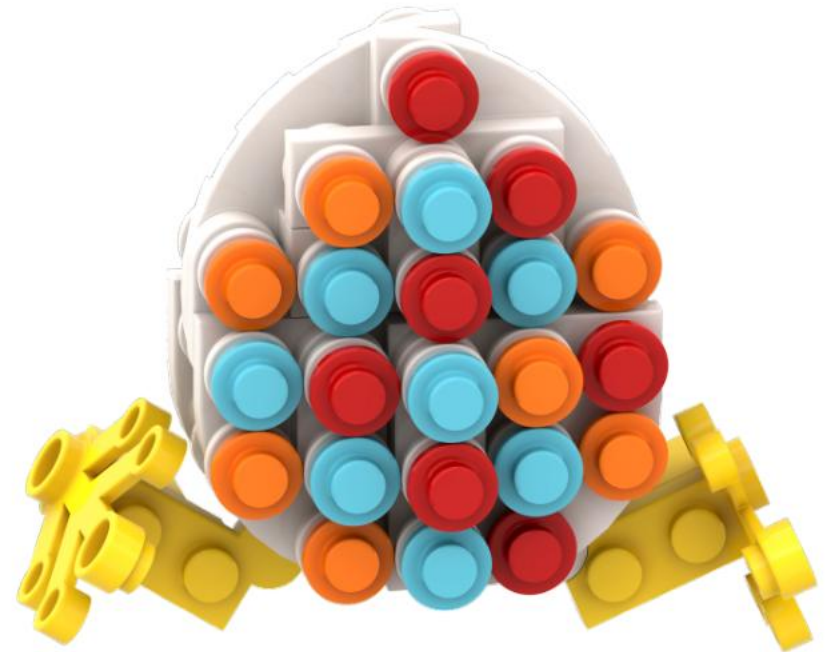
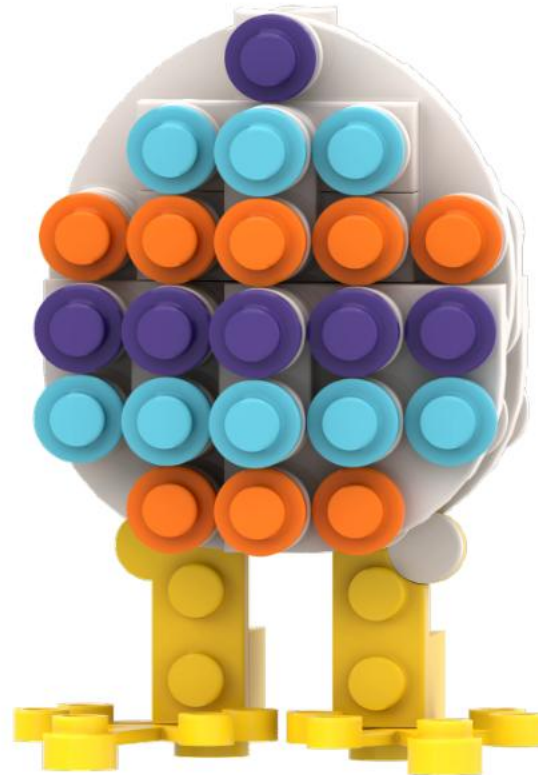
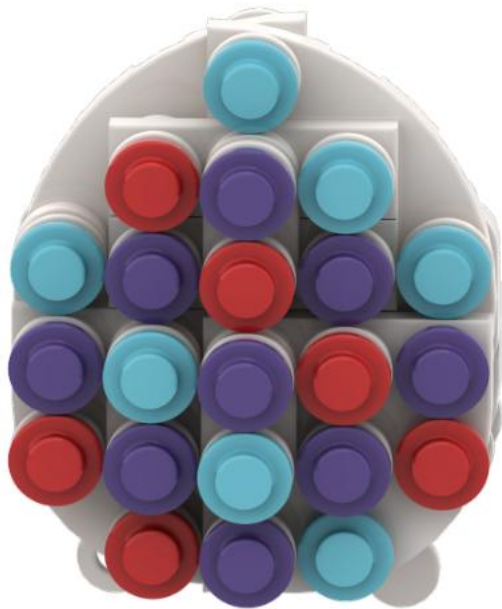

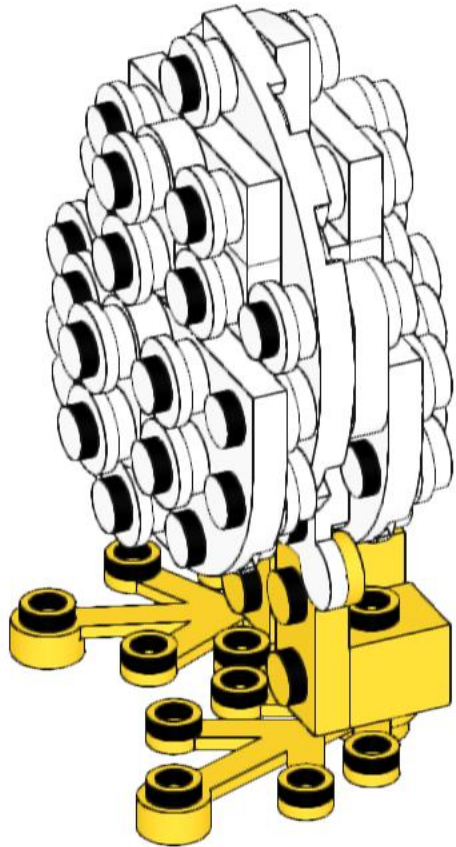

48x
4073
White



8x
35480
White

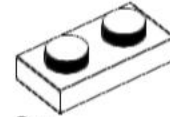

2x
3023
White

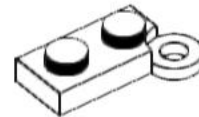

1x
2429
White

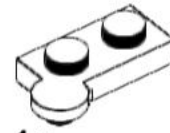

1x
2430
White

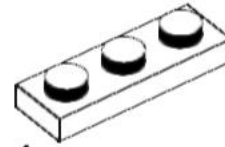

4x
3623
White

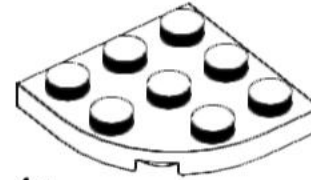

4x
30357
White

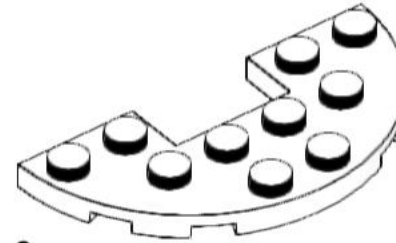

2x
18646
White



2x
87087 New
Yellow

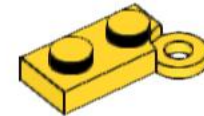

1x
2429
Yellow

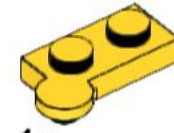

1x
2430
Yellow

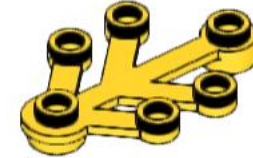

2x
2423
Yellow